

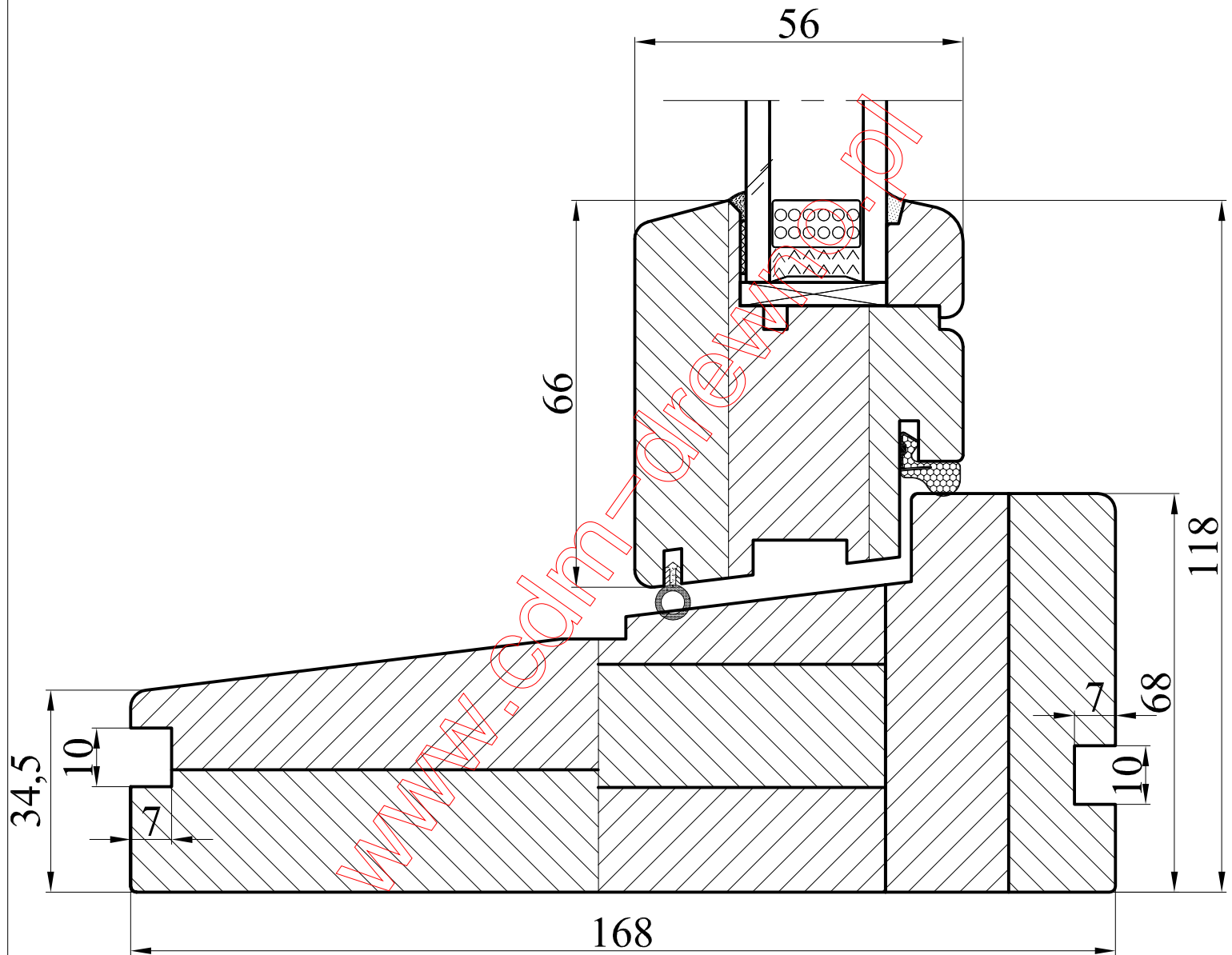



A

A-A

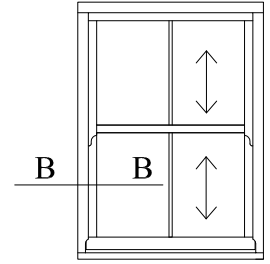
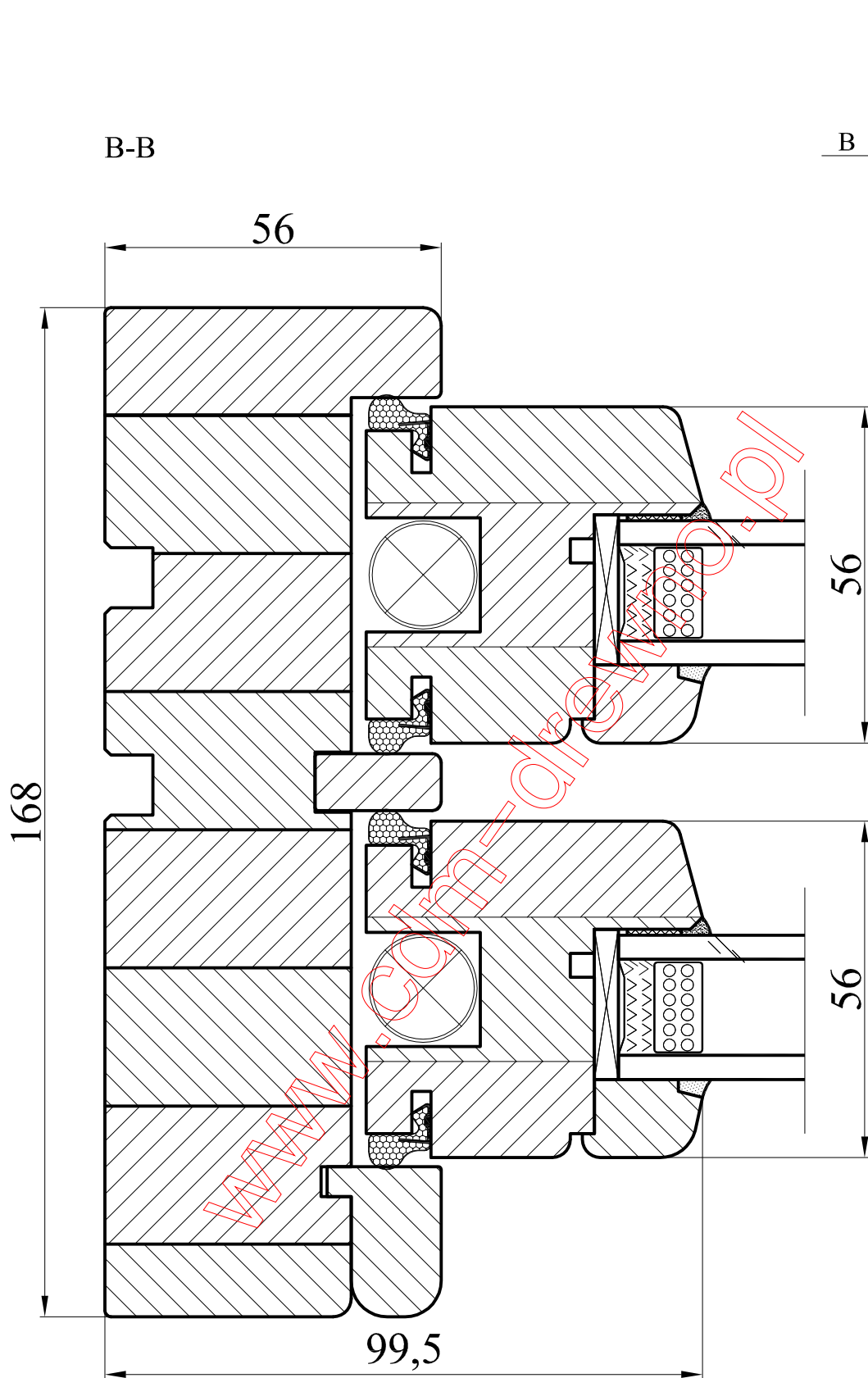

Section	Frame + sash	Date	25.11.2009	 CDM PRODUCENT OKIEN I DRZWI CDM Sp. z o.o. ul. Wojska Polskiego 112A, 16-400 Suwałki tel. + 48 87 565 36 45, fax + 48 87 565 36 68 www.cdm-drewno.pl
Profile	SLIDE SASH	Scale	1:1	
Detail	W/SS-168/2_001	Format	A4	



Section	Jamb + sash	Date	25.11.2009	 CDM PRODUCENT OKIEN I DRZWI CDM Sp. z o.o. ul. Wojska Polskiego 112A, 16-400 Suwałki tel. + 48 87 565 36 45, fax + 48 87 565 36 68 www.cdm-drewno.pl
Profile	SLIDE SASH	Scale	1:1	
Detail	W/SS-168/2_002	Format	A4	

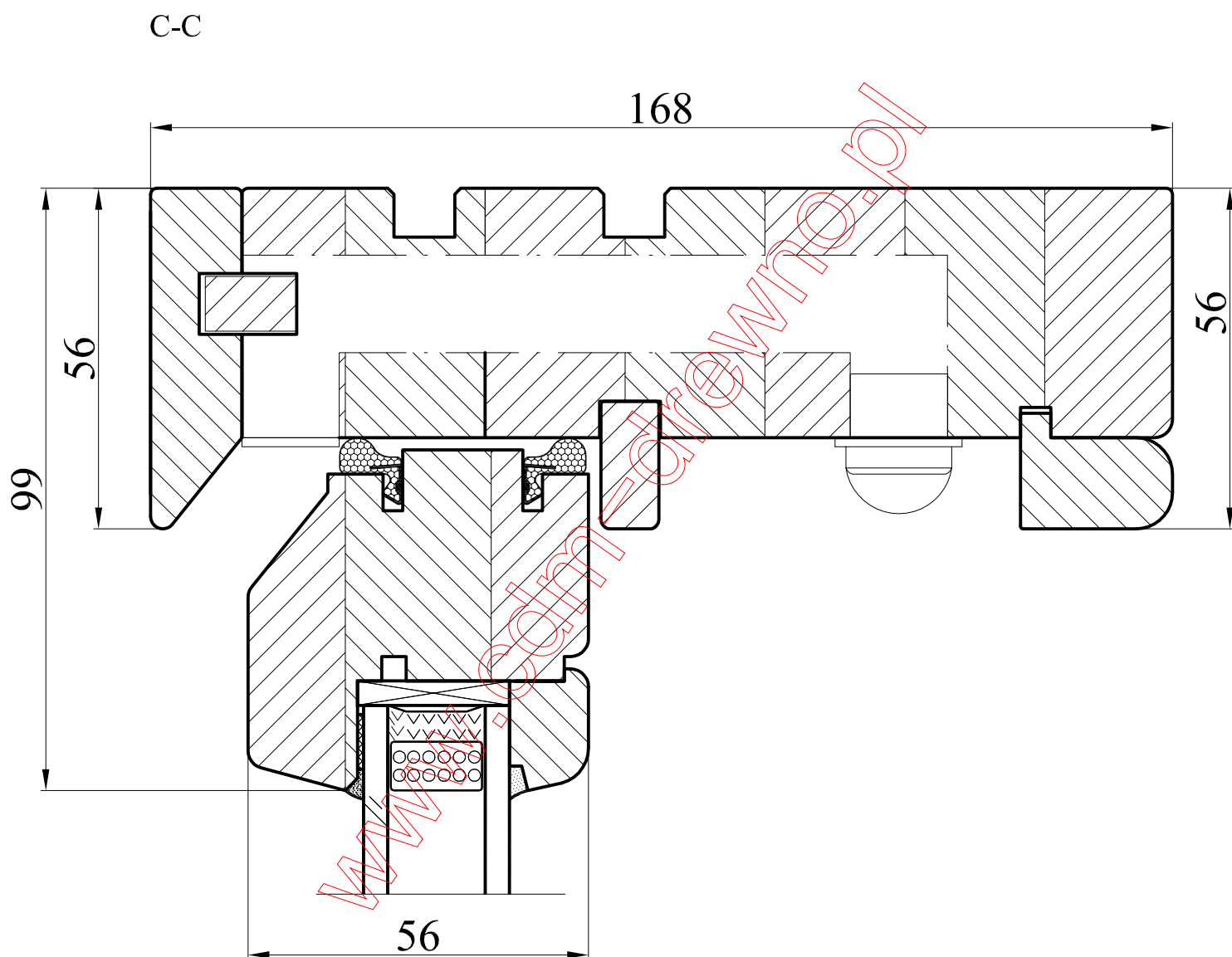
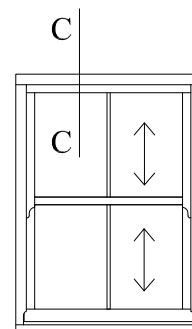

Section	Frame + sash window head	Date	25.11.2009	 PRODUCENT OKIEN I DRZWI CDM Sp. z o.o. ul. Wojska Polskiego 112A, 16-400 Suwałki tel. + 48 87 565 36 45, fax + 48 87 565 36 68 www.cdm-drewno.pl
Profile	SLIDE SASH	Scale	1:1	
Detail	W/SS-168/2_003	Format	A4	

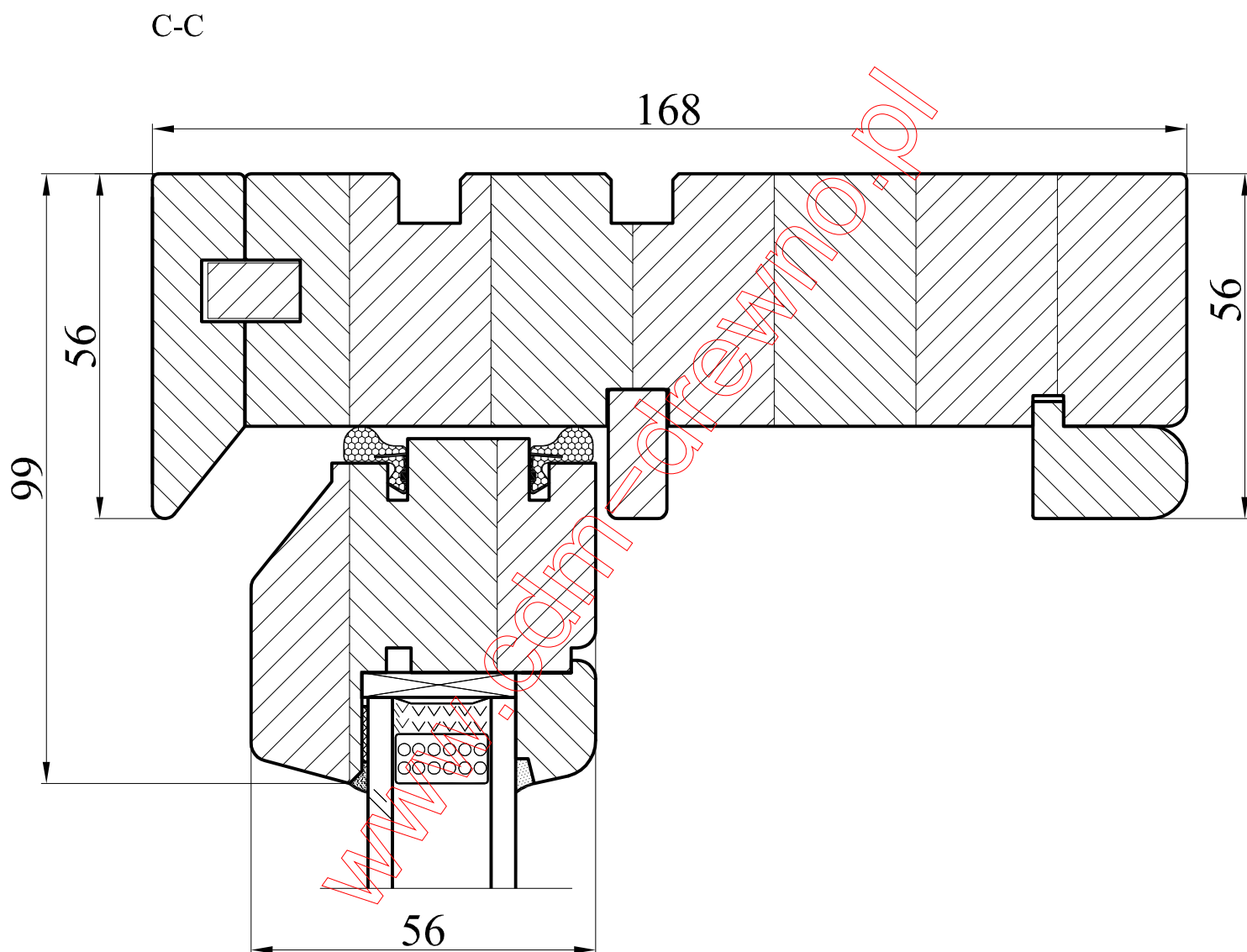
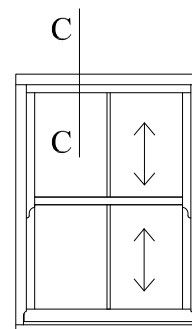

Section	Frame + sash window head	Date	25.11.2009	 CDM PRODUCENT OKIEN I DRZWI <small>CDM Sp. z o.o. ul. Wojska Polskiego 112A, 16-400 Suwałki tel. + 48 87 565 36 45, fax + 48 87 565 36 68 www.cdm-drewno.pl</small>
Profile	SLIDE SASH	Scale	1:1	
Detail	W/SS-168/2_004	Format	A4	

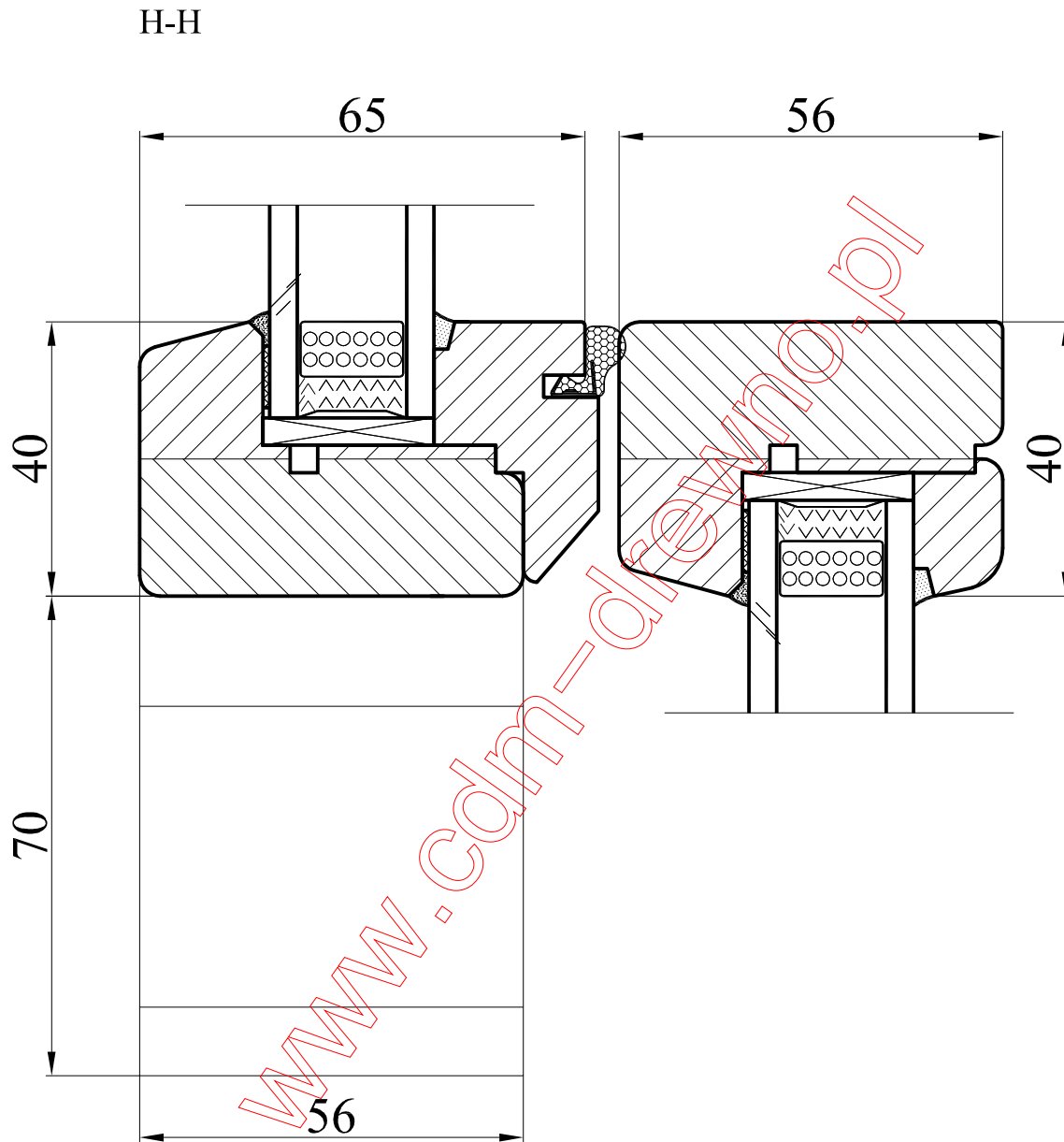
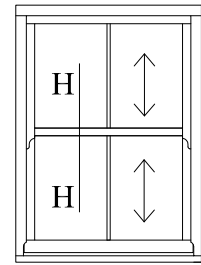

Section	Window sash	Date	25.11.2009	 PRODUCENT OKIEN I DRZWI <small>CDM Sp. z o.o.</small> <small>ul. Wojska Polskiego 112A, 16-400 Suwałki</small> <small>tel. + 48 87 565 36 45, fax + 48 87 565 36 68</small> <small>www.cdm-drewno.pl</small>
Profile	SLIDE SASH	Skala	1:1	
Detail	W/SS-168/2_005	Format	A4	

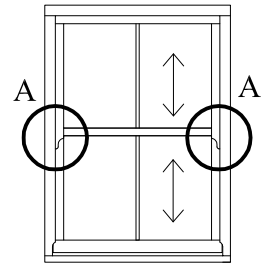

detal A

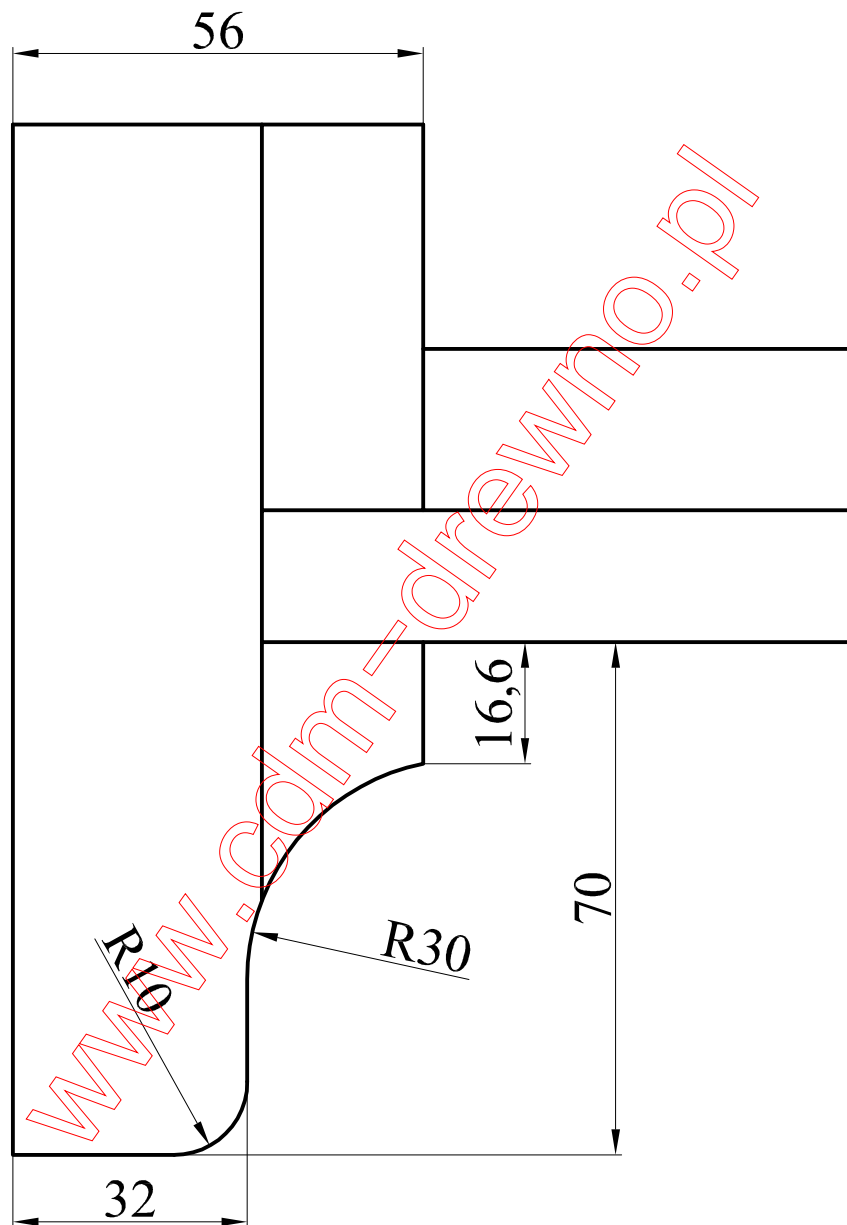

Title	Sash milling	Date	25.11.2009	 CDM PRODUCENT OKIEN I DRZWI CDM Sp. z o.o. ul. Wojska Polskiego 112A, 16-400 Suwałki tel. + 48 87 565 36 45, fax + 48 87 565 36 68 www.cdm-drewno.pl
Profile	SLIDE SASH	Scale	1:1	
Detail	W/SS-168/2_006	Format	A4	

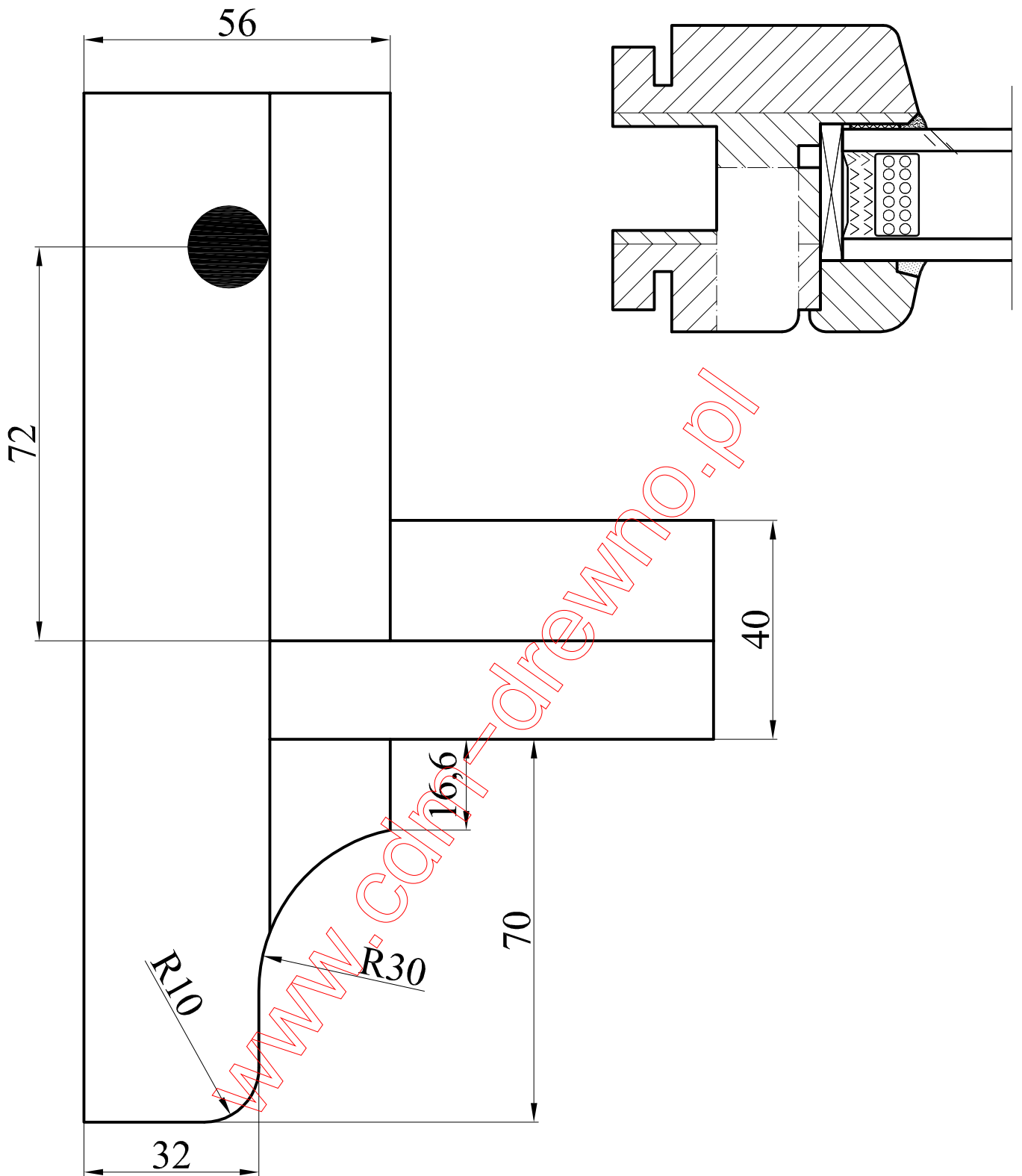

Title	drilling hole for 'Ventlock'	Date	25.11.2009
Profile	SLIDE SASH	Scale	1:1
Detail	W/SS-168/2_007	Format	A4



PRODUCENT OKIEN I DRZWI

CDM Sp. z o.o.

ul. Wojska Polskiego 112A, 16-400 Suwałki
tel. + 48 87 565 36 45, fax + 48 87 565 36 68

www.cdm-drewno.pl